

All stainless steel pressure gauges with capsule element

Nominal size ND 100 and 160
Accuracy class 1.6

according to DIN EN 837-3

Features

- High reliability and long service life
- Overload protection ,up to x 10
- Zero adjustment
- Copper alloy measuring system

Applications

- Pharmaceutical industry
- filter status monitoring
- furnace monitoring
- air-conditioning
- vacuum measurements and laboratory applications
- leakage tests, filter and status monitoring,



Models and ND	MK-30 100	MK-34 100	MK-30 160	MK-34 160
Connection	bottom	back,centric	bottom	back,centric
Ranges in mbar	0...4, 6, 10, 16, 25, 40, 60, 100, 160, 250, 400, 600 -4 / 0, -6 / 0, -10 / 0, -16 / 0, -25 / 0, -40 / 0, -60 / 0, -100 / 0, -160 / 0, -250 / 0, -400 / 0, -600 several other ranges (-100..+150) a. o.			
Applications	Constant load : up to full scale value Alternating load : up to 0,9 x full scale value short-time :overload capacity 1.3 x			
Case	stainless steel 1.4301			
Bezel	stainless steel 1.4301			
Window	Laminated safety glass			
Dial	Aluminium white, scale and imprint black			
Pointer	Aluminium, black			
Movement	Stainless steel			
Measuring element	Stainless steel 1,4571			
Pressure connection	SW 22, Stainless steel 1.4571			
Connectionthread	G 1/2 B			
Protection	IP 54 to EN 60529 / IEC 529			
Temperature	Medium: -20°C bis 80°C, ambient -25°C bis 60°C			
Weight	0,6 kg		1,0 kg	

Dimensions

Connection bottom

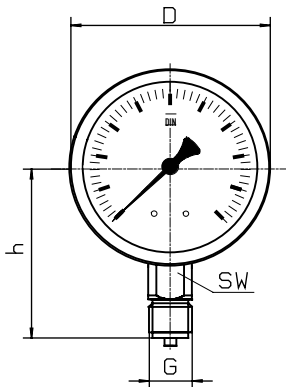

Connection back, centric

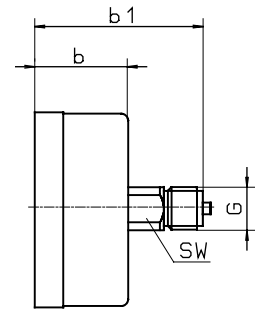
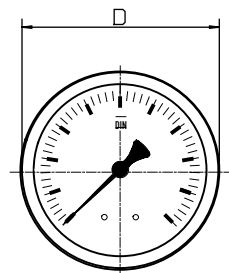
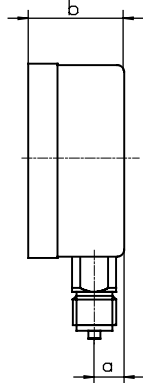

Front flange

Rear flange

Front flange

with triangle bezel and U-clamp,

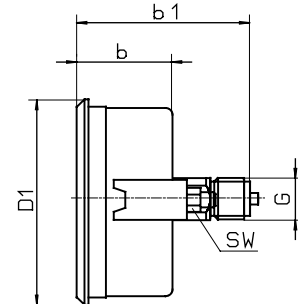
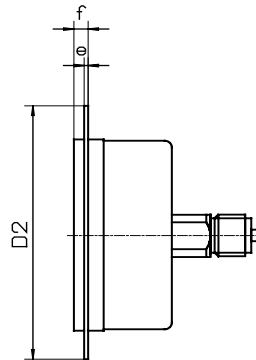
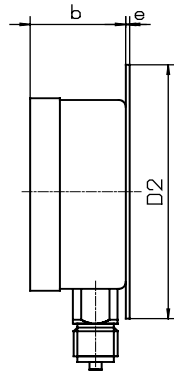
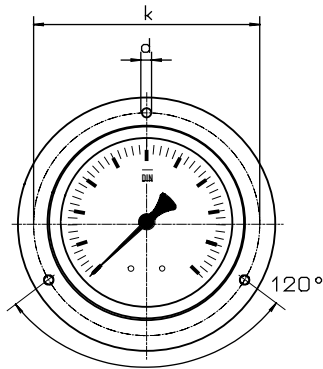

Dimensions in mm														
Model	NG	D	a	b	b1	h	D1	D2	e	f	k	d	sw	G
MK-30	100	101	15	49	-	86	107	132	2	6	116	5	22	G 1/2 B
MK-34	100	101	-	49	85	-	107	132	2	6	116	5	22	G 1/2 B
MK-30	160	160	15	51	-	118	-	196	3	8	178	5,6	22	G 1/2 B
MK-34	160	160	-	51	86	-	166	196	3	8	178	5,6	22	G 1/2 B

Modelspecification

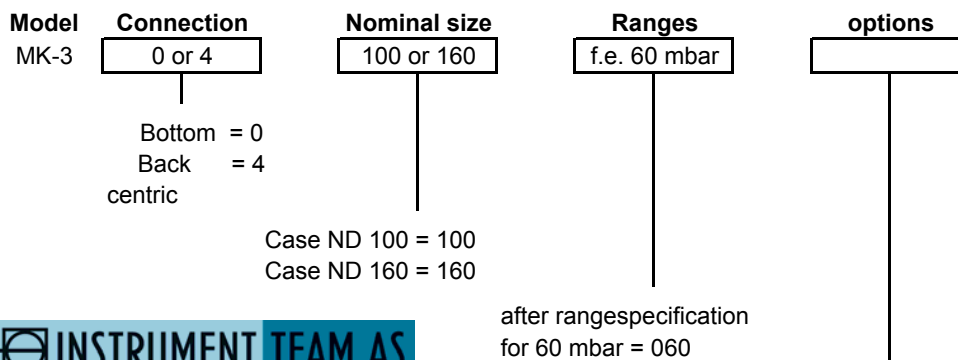

for example : front mounting flange